



ANLEITUNG

QUALITÄTS-
HOLZBAUSET

Vollholz Natur mit **Stahlwerkzeugen**



**Für große und
kleine Handwerker!**



Art. 465

Inhalt / content / contenu / contenuto / contenido



Beispiele / Examples



Beispiel Muldenkipper / Example dump truck

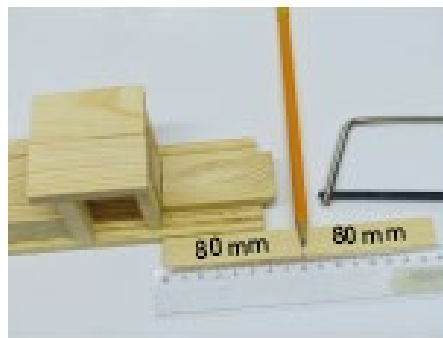
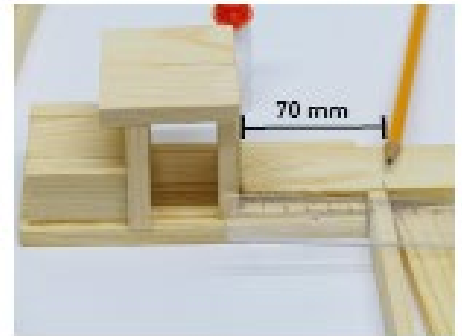
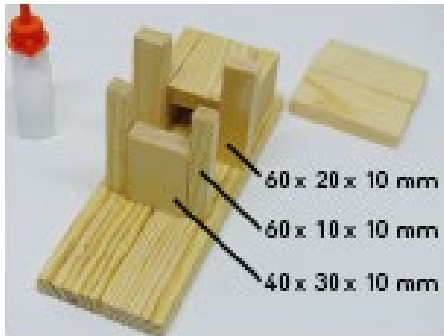
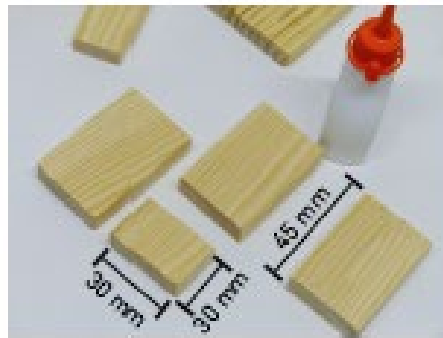
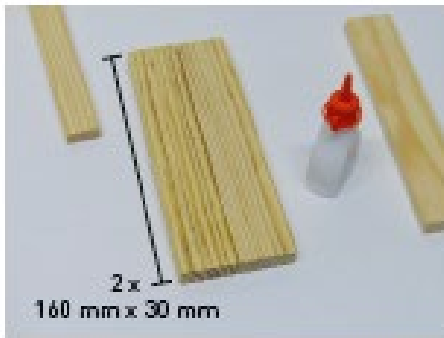

Beispiel Gabelstapler / Example klift truck

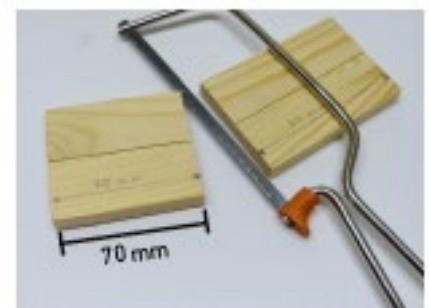
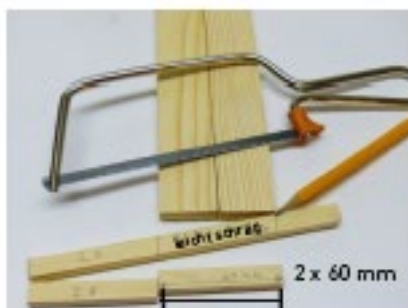
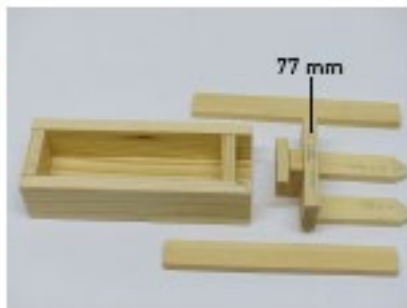
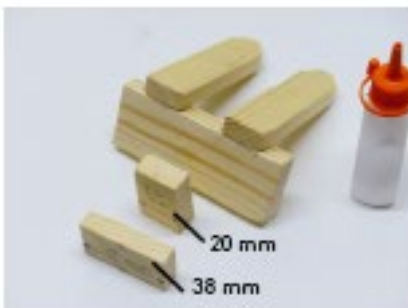
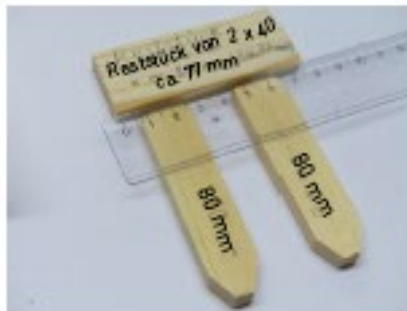
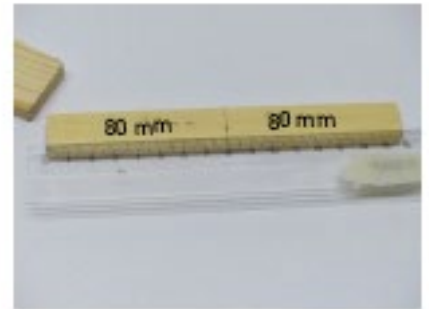
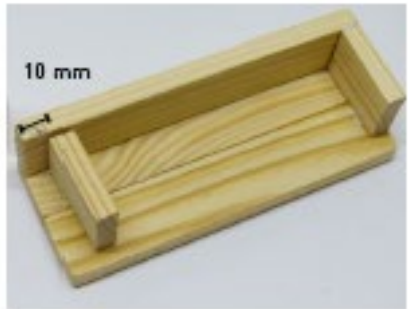

Beispiel Auto / Example car



Von Schülern gebastelt / Made by students

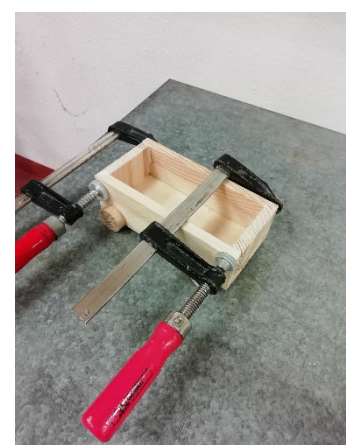
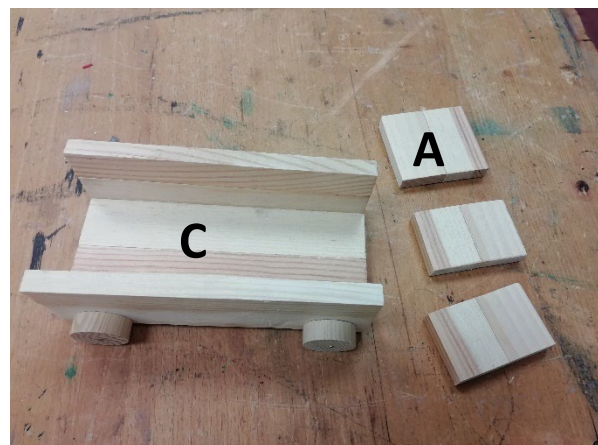
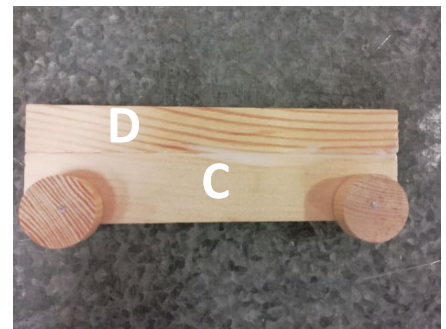
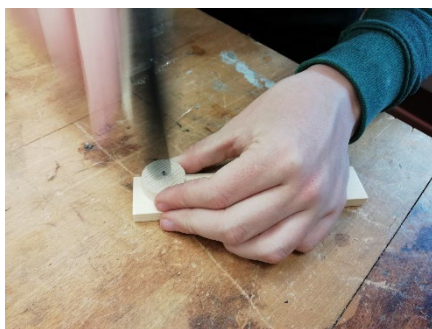
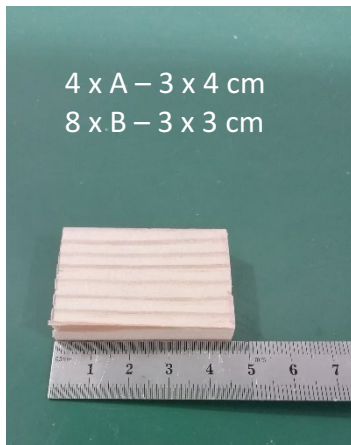

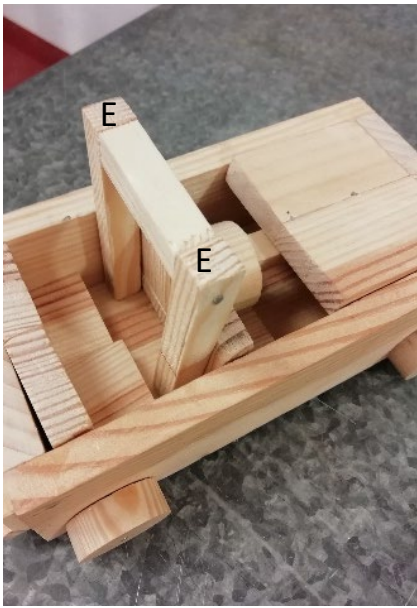
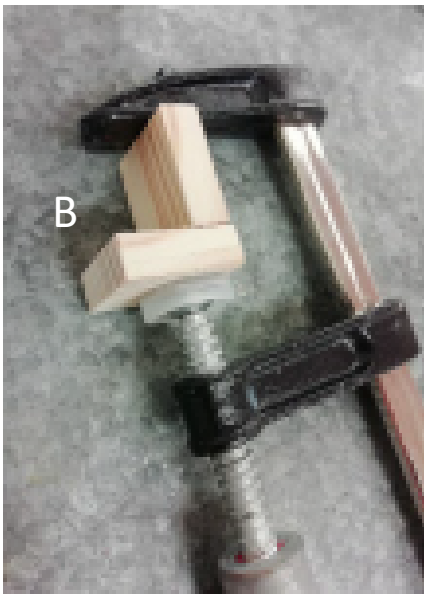

E von unten
befestigen

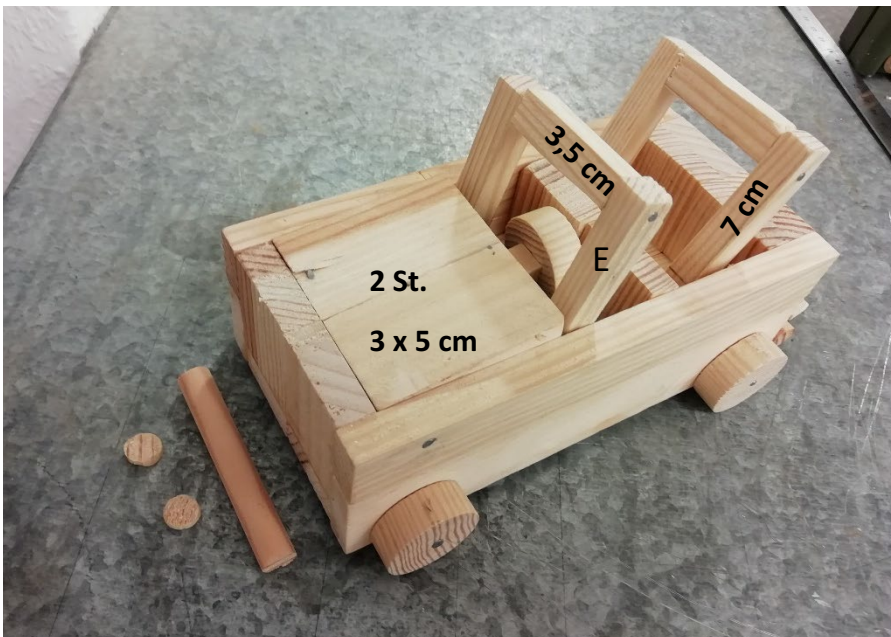

Beispiel Feuerwehr / Example fire truck



Von Schülern gebastelt / Made by students

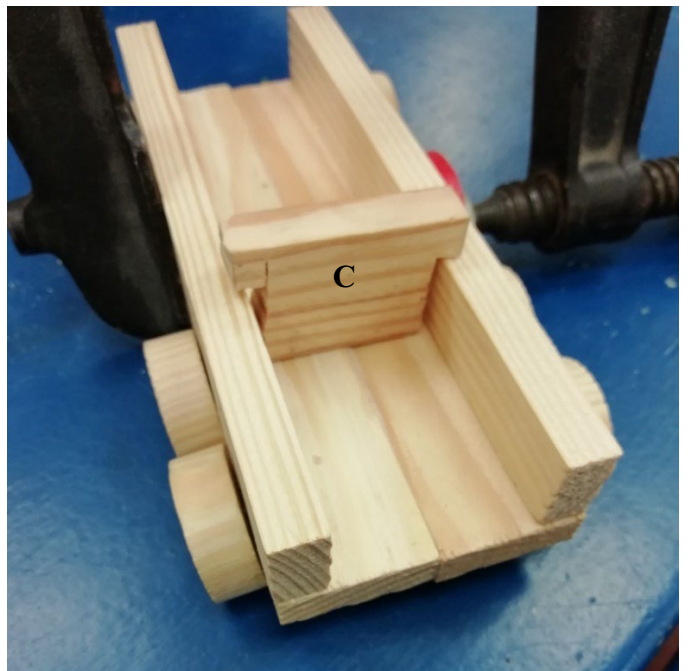
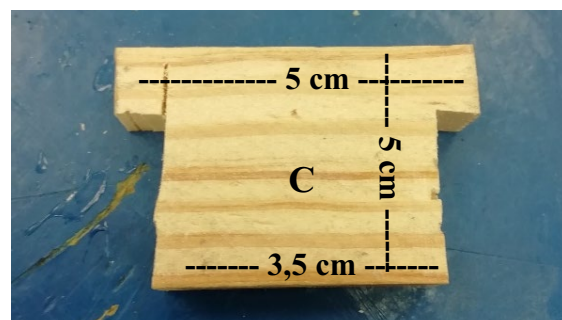
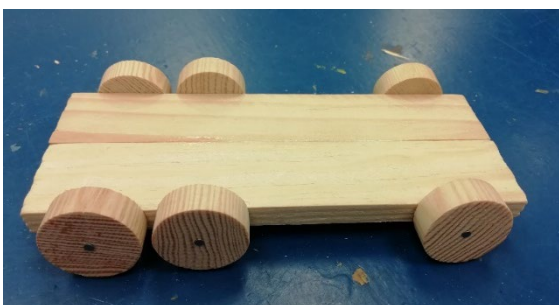
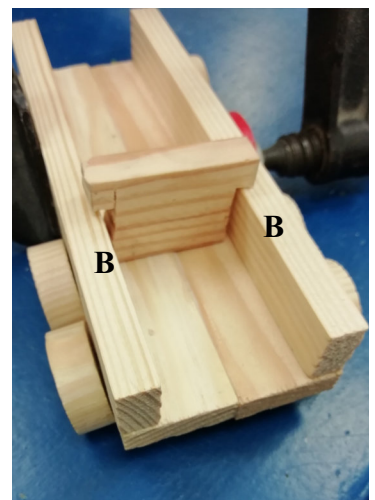
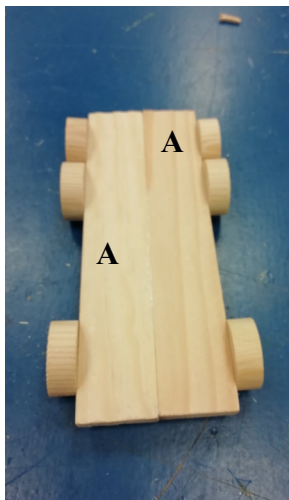

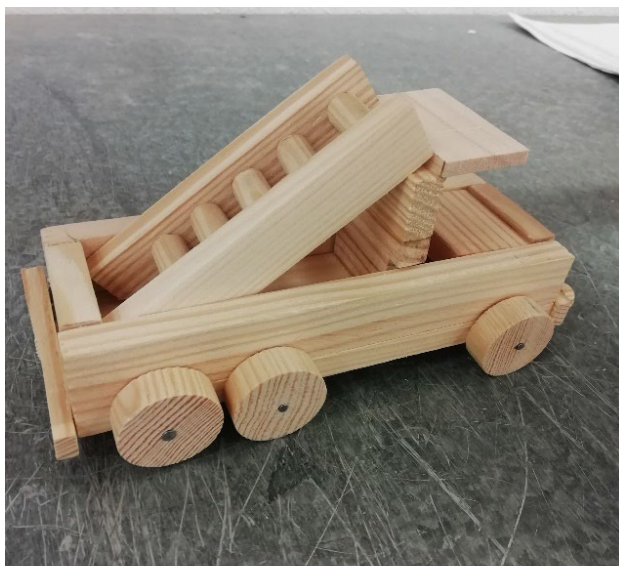
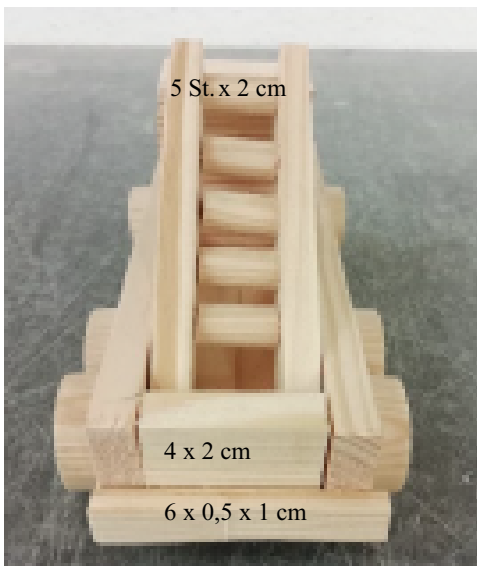
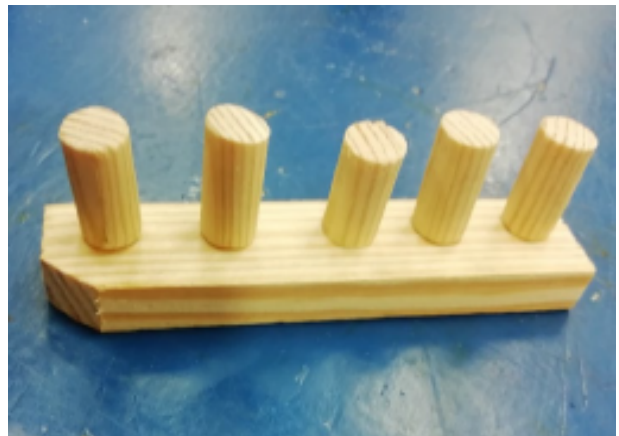
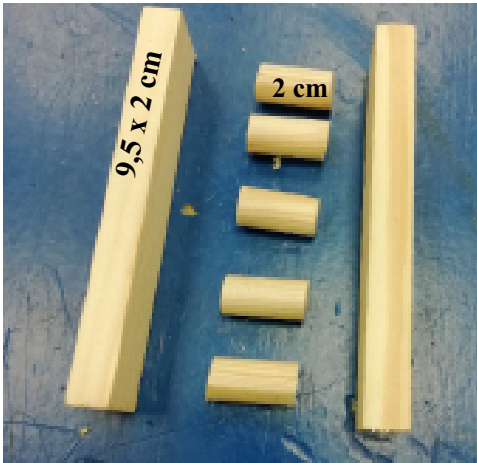
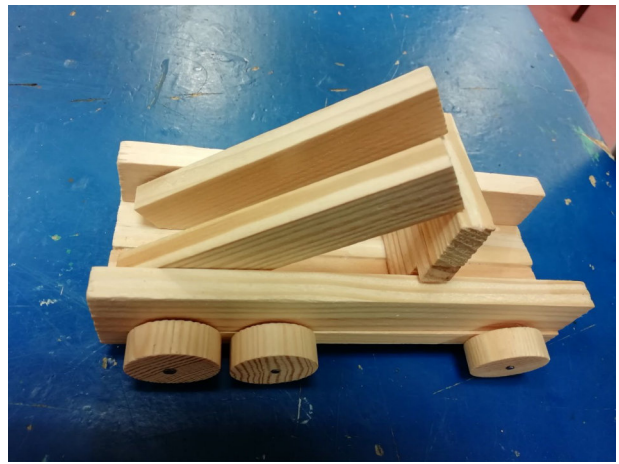

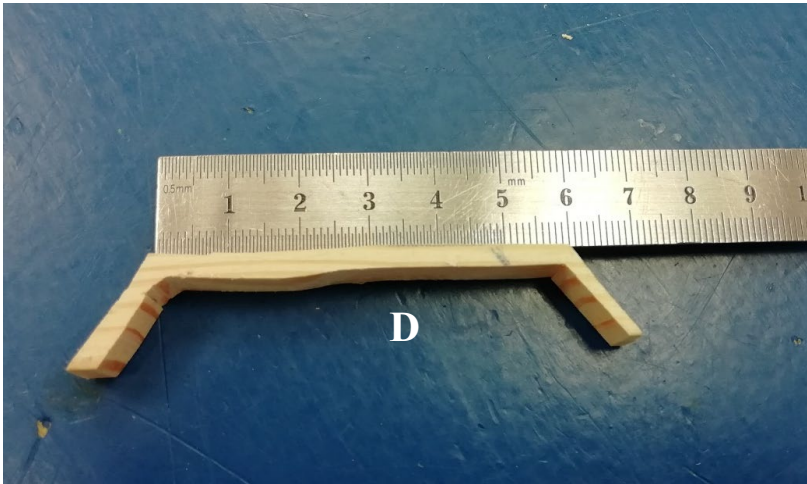

D = 6 cm

E = 2 cm

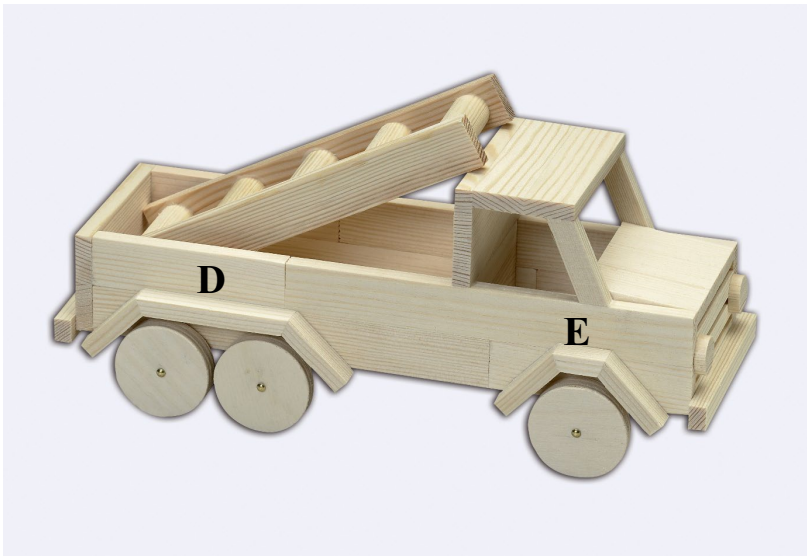

Beispiel Flugzeug / Example air plane



Von Schülern gebastelt / Made by students

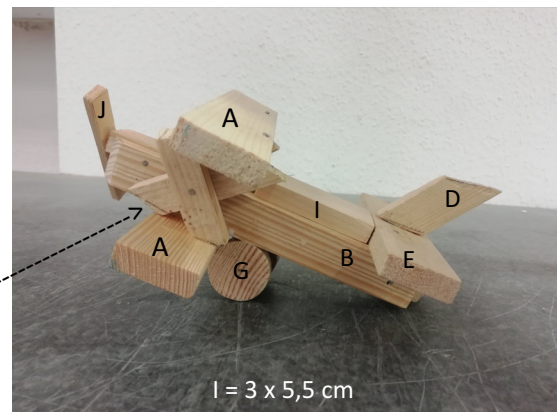
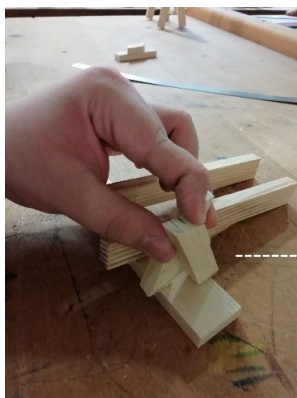
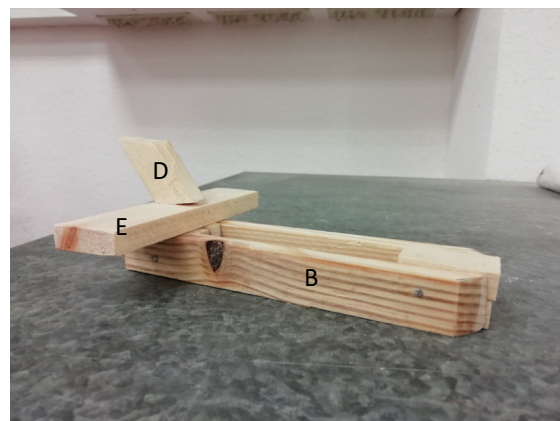
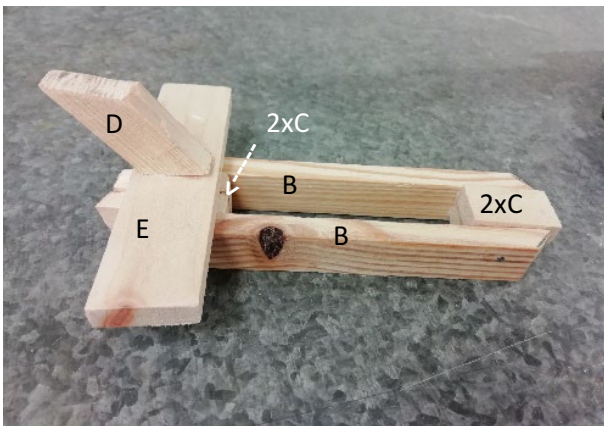
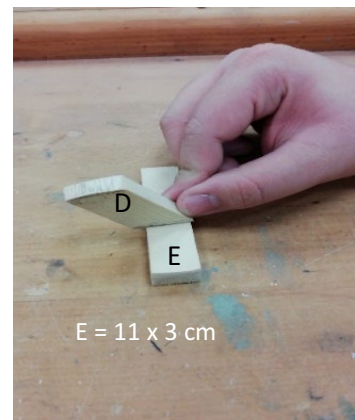
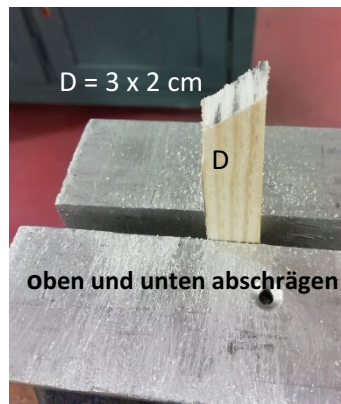
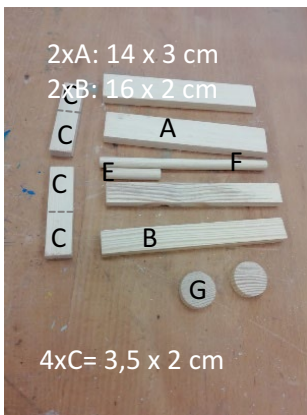

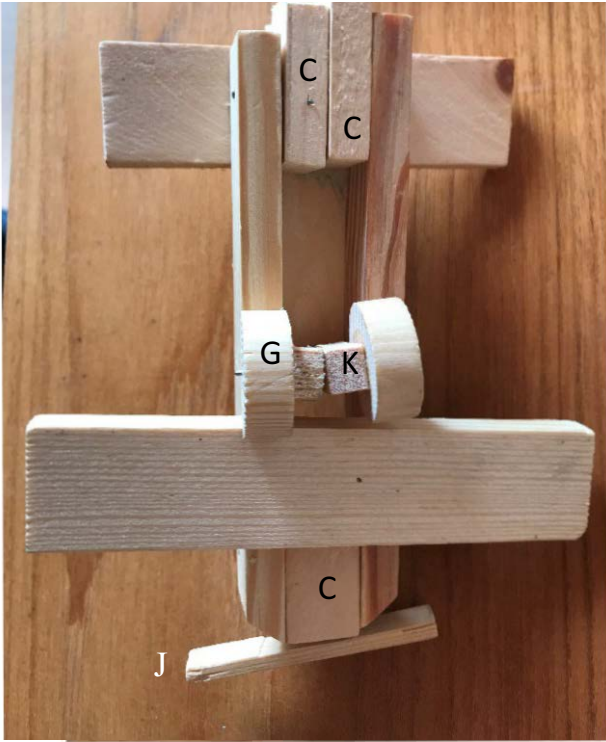

Propeller J = 7 x 1 x 0,5 cm

2 Achsen K = 3 x 1 x 1 cm

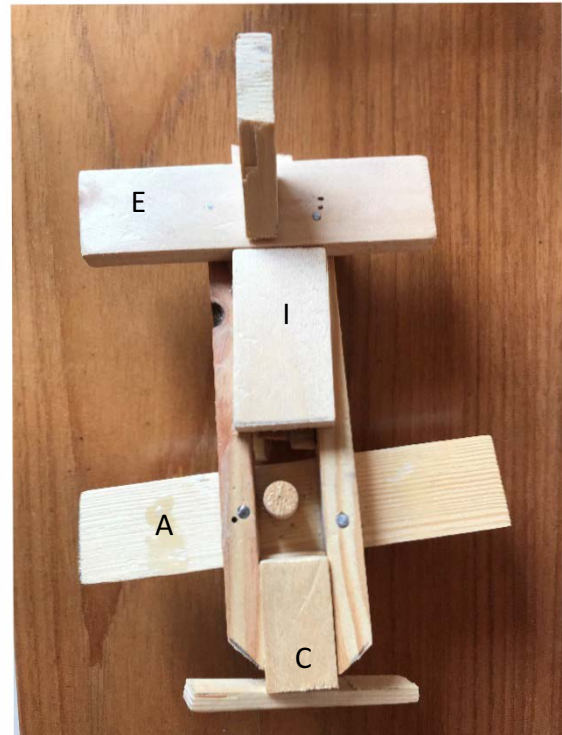

I = 5,5 x 3 cm

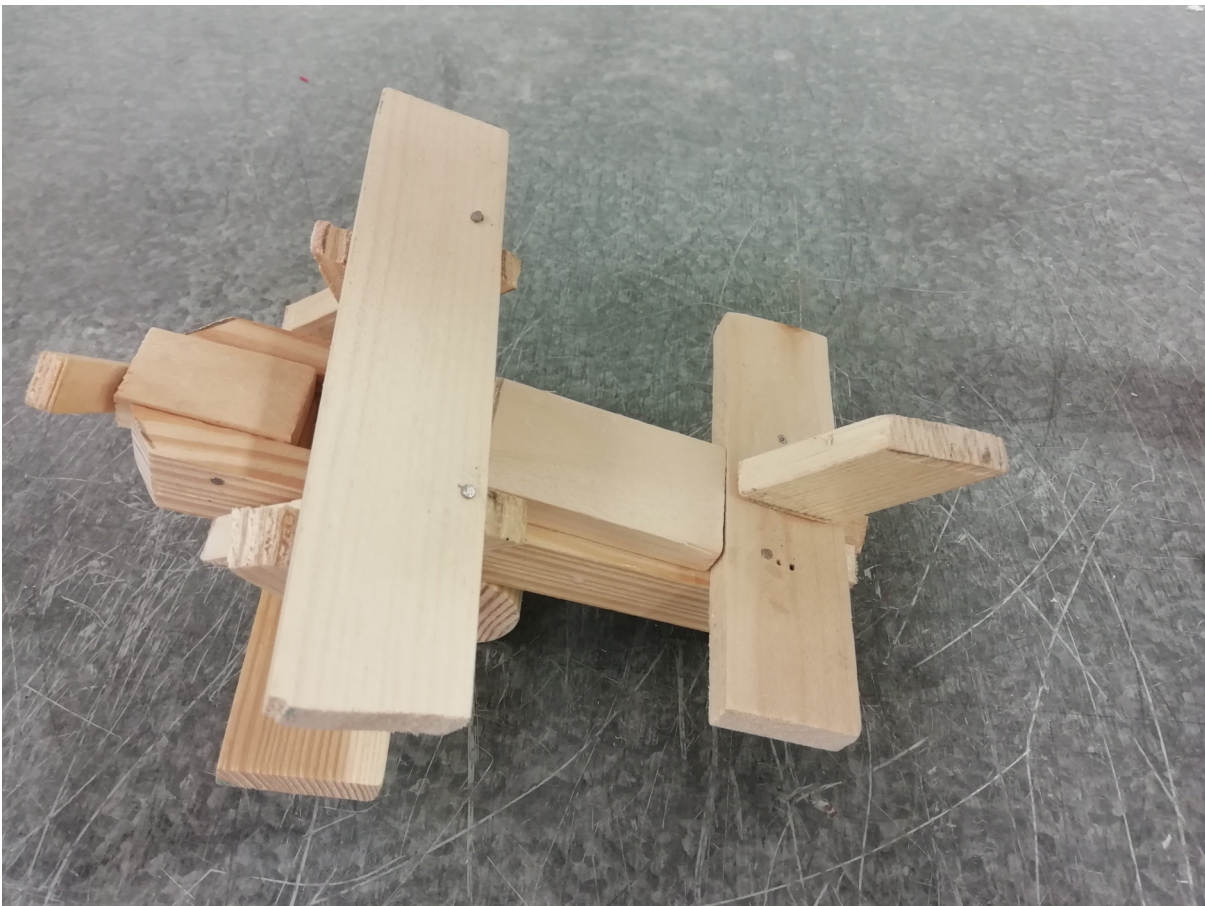

Beispiel Schaukel / Example swing



Von Schülern gebastelt / Made by students

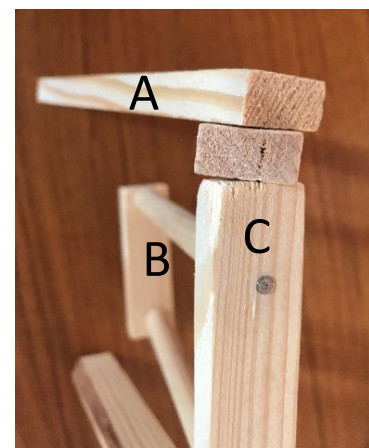
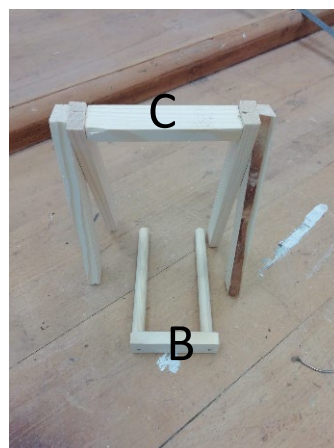
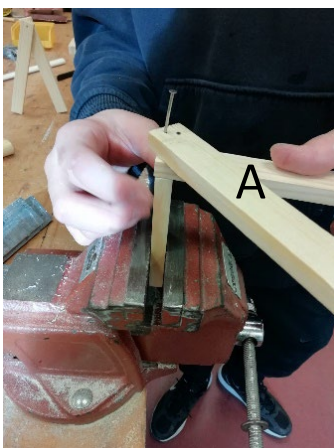
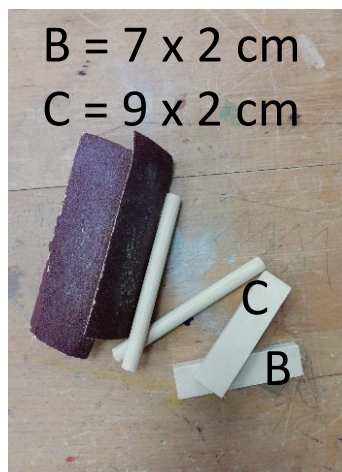
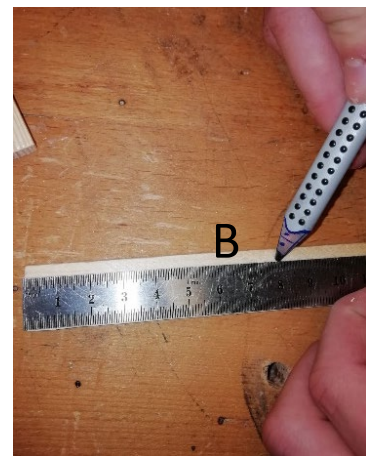
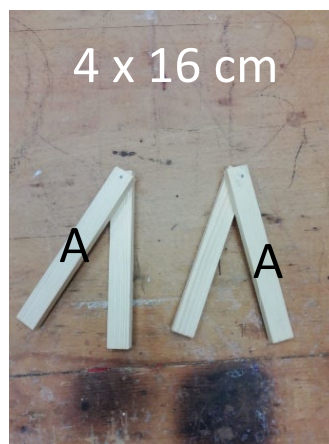

DE

 Bevor Sie das Produkt in Gebrauch nehmen, lesen Sie diese Gebrauchsanleitung aufmerksam und beachten Sie die Sicherheitshinweise! Für Schäden oder Unfälle, die durch Nichtbeachtung der Anleitung und Sicherheitsvorgaben entstehen, übernehmen wir keine Haftung. Die Anleitung ist sorgfältig aufzubewahren und bei Weitergabe des Produktes mit zu übergeben.

 **Sicherheitshinweise**
Vorsicht! Benutzung unter unmittelbarer Aufsicht von Erwachsenen. Das Produkt einschließlich Zubehör darf unbeaufsichtigt nicht in die Hände von Kindern unter 8 Jahren gelangen.

 **Altersempfehlung**
ab 8 Jahren

 **Inhalt**
Stahlzange, Stahlhammer, Holzleim, 90 Nägel, Handsäge, 6 Vollholz Natur Scheiben rund Ø 3 cm x 1 cm, 4 Vollholz Natur Stäbe rund Ø 1 cm, Länge 16 cm, 7 Vollholz Natur Stäbe eckig 16 x 2 x 0,7 cm, 8 Vollholz Natur Stäbe eckig 16 x 3 x 1 cm

IT

 Prima di prendere in mano il kit, è bene leggere con attenzione i consigli della guida di costruzione e di attenersi alle misure di sicurezza indicate. Decliniamo ogni responsabilità per danni o incidenti derivanti dalla non osservanza della guida e delle misure di sicurezza. Queste istruzioni vanno conservate e consegnate insieme al prodotto nel caso di cessione.

 **Consigli di sicurezza**
Attenzione! Utilizzare solo sotto la diretta supervisione di un adulto. Tenere il prodotto e i suoi accessori lasciati incustoditi fuori dalla portata dei bambini di età inferiore ai 8 anni.

 **Età consigliata**
a partire dai 8 anni

 **Contenuto**
Tenaglia in acciaio, martello, colla per legno, 90 chiodi, sega a mano, 6 dischetti legno massiccio Ø 3 cm x 1 cm, 4 listelli legno massiccio da 16 cm, Ø 1 cm, 7 listelli legno massiccio da 16 cm, 2 x 0,7 cm, 8 listelli legno massiccio da 16 cm, 3 x 1 cm

GB

 Carefully read the directions of usage and the safety instructions before using this product! We do not take any responsibility for damages or accidents caused by disobedience of the instructions. We therefore recommend keeping the instructions in a safe place and when passing on the product always include the instructions as well.

 **Safety Instructions**
Caution! To be used under the direct supervision of an adult only. Children under the age of 8 should never use the product - including any attachments - without the direct supervision of an adult!

 **Recommended age**
8 years and older

 **Content**
Steel pincers, hammer, glue for wood, 90 nails, handsaw, 6 discs in massive wood Ø 3 cm x 1 cm, 4 strips massive wood Ø 1 cm, 16 cm long, 7 massive wood strips, 2 x 0.7 cm, 16 cm long, 8 massive wood strips, 3 x 1 cm, 16 cm long

ES

 Antes de empezar a usar el producto, ¡lea detenidamente las instrucciones de uso y preste atención a las precauciones! No asumimos ninguna responsabilidad por los daños o accidentes que se pudieran ocasionar por el incumplimiento de estas instrucciones e indicaciones de seguridad. Guarde las instrucciones con cuidado e inclúyalas con el producto si lo entrega a otra persona.

 **Precauciones**
¡Atención! Utilícese bajo la supervisión directa de un adulto. El producto y los accesorios no se deben dejar sin vigilancia en las manos de niños menores de 8 años.

 **Grupo de edad**
a partir de los 8 años

 **Contenido**
Tenazas de acero, martillo, cola de carpintero, 90 clavos, serrucho, 6 discos madera maciza Ø 3 cm x 1 cm, 4 listones madera de 16 cm, Ø 1 cm, 7 listones madera de 16 cm, 2 x 0,7 cm, 8 listones madera de 16 cm, 3 x 1 cm

FR

 Avant de prendre en main le kit veuillez lire attentivement les conseils et instructions de montage ainsi que les mesures de sécurité. Nous ne répondons pas pour des dégâts ou accidents dus à l'inobservance des instructions et des mesures de sécurité. Gardez soigneusement ces instructions avec le kit.

 **Conseils de sécurité**
Attention ! A employer seulement sous le contrôle d'un adulte. Les enfants de moins de 8 ans ne devraient pas prendre en main le matériel et les outils sans surveillance.

 **Age conseillé**
à partir de 8 ans

 **Contenu**
Tenaille en acier, marteau, colle de menuisier, 90 clous, scie à main, 6 disques bois massif Ø 3 cm x 1 cm, 4 baguettes de 16 cm, bois massif Ø 1 cm, 7 baguettes de 16 cm, bois massif, 2 x 0,7 cm, 8 baguettes de 16 cm, bois massif, 3 x 1 cm



www.pebaro.de



**Bausch GmbH & Co. KG • Blombachstraße 21-23
42369 Wuppertal • Germany • www.pebaro.de**

